



INSTALLATION • OPERATION • MAINTENANCE INSTRUCTIONS

TYPE COQ NEGATIVE SEQUENCE GENERATOR RELAY

CAUTION Before putting protection relays into service, remove all blocking which may have been inserted for the purpose of securing the parts during shipment. Make sure that all moving parts operate freely. Inspect the contacts to see that they are clean and can close properly. Operate the relay to check the settings and electrical connections.

APPLICATION

The COQ is used to prevent a synchronous machine from being damaged due to negative sequence fault currents. Two varieties are available, as shown in figures 2 and 3, depending upon whether the neutral can be formed at the COQ or whether the neutral must be formed elsewhere. (See external schematic, figures 8 and 9.)

CONSTRUCTION AND OPERATION

The COQ consists of an induction disc overcurrent unit, a negative sequence filter, and an indicating contactor switch (ICS).

Overcurrent Unit

This is an induction-disc type unit operated by negative sequence quantities supplied to an electromagnet in the rear of the relay. A voltage is induced in the secondary coil of this electromagnet by transformer action of the main coil. Both coils are located on the center leg of the electromagnet. Current flow is from the secondary coil to coils on the outer legs of the electromagnet. The reaction between the outer leg coil fluxes and the main coil flux creates an operating torque on a spiral shaped aluminum disc mounted on a vertical shaft.

Indicating Contactor Switch Unit (ICS)

The d-c indicating contactor switch is a small clapper type device. A magnetic armature, to which leaf-spring mounted contacts are attached, is attracted to the magnetic core upon energization of the switch. When the switch closes, the moving contacts bridge two stationary contacts, completing the trip circuit.

Also during this operation two fingers on the armature deflect a spring located on the front of the switch, which allows the operation indicator target to drop. The target is reset from the outside of the case by a push rod located at the bottom of the cover.

The front spring, in addition to holding the target, provides restraint for the armature and thus controls the pickup value of the switch.

CHARACTERISTICS

Overcurrent Unit

The COQ negative sequence relay is available with the following negative sequence current taps:

3 3.25 3.5 3.8 4.2 4.6 5.0

These tap values represent the current transformer secondary amperes which correspond to one per unit generator current. At these values of negative sequence current, the moving contact will leave the time dial stop and reach the stationary contacts in a time as determined by the time dial setting and as shown by Fig. 7. For example, with a time dial setting of "4" the relay will close its contacts in 30 seconds with the above tap currents applied to the relay.

As shown by the curves of figure 5, the relay's characteristic is defined by a generator characteristic $I^2T = K$. The relay characteristic is such that it coincides with the generator characteristic at 1 per unit negative sequence current but at higher values of negative sequence current, the relay characteristic is substantially parallel and slightly less than the generator characteristic. In this manner, a suitable margin of safety is obtained between the two characteristics.

All possible contingencies which may arise during installation, operation, or maintenance, and all details and variations of this equipment do not purport to be covered by these instructions. If further information is desired by purchaser regarding his particular installation, operation or maintenance of his equipment, the local Westinghouse Electric Corporation representative should be contacted.

SUPERSEDES I.L. 41-161F

*Denotes change from superseded issue.

EFFECTIVE APRIL 1973

TYPE COQ RELAY

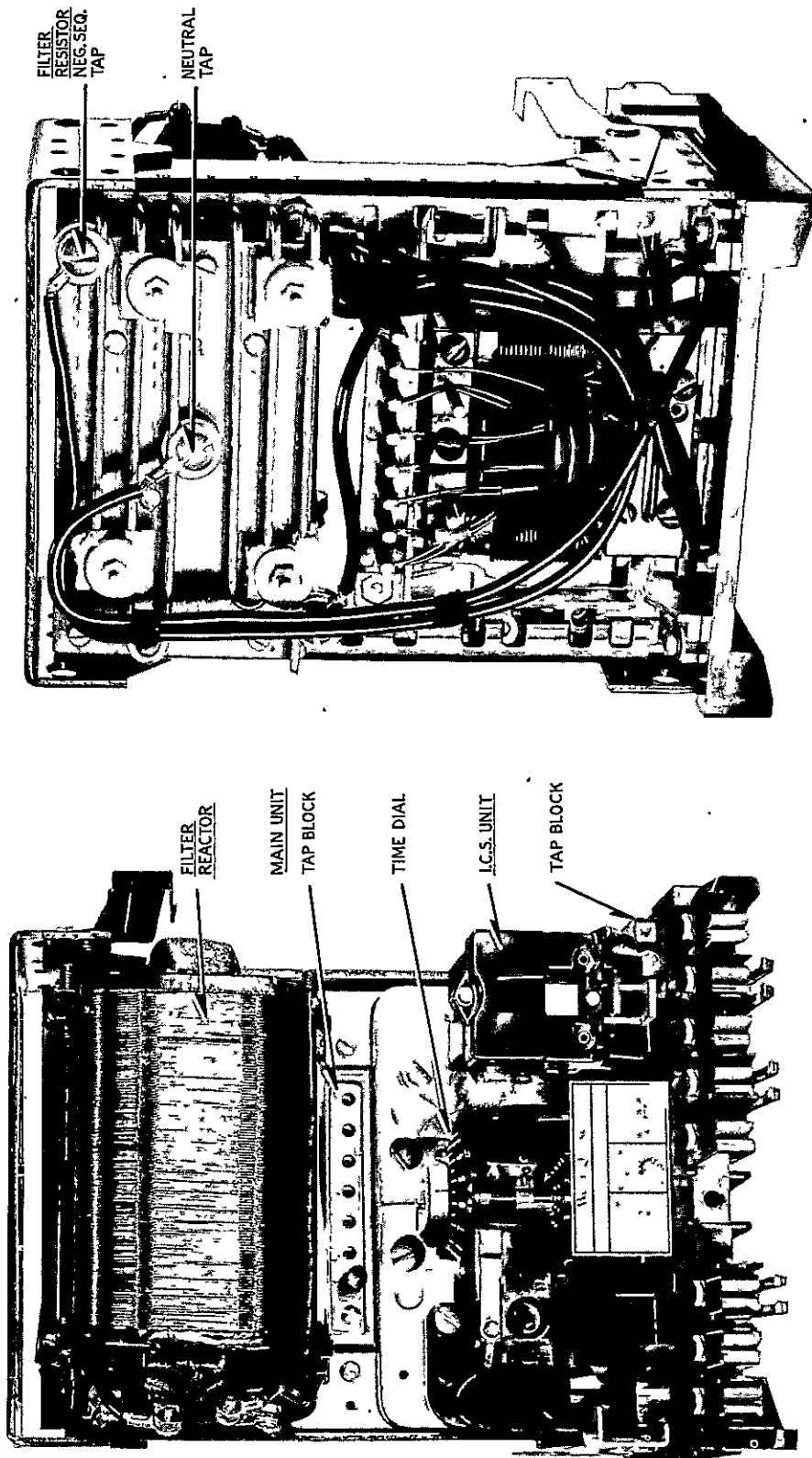

Fig. 1. Type COQ Relay - Without Case.

2

Figure 5 defines the relay characteristics for two generators - one with a permissible constant of "30" and the other with a constant of "90". The time dial settings for these constants are "4" and "11" respec-

tively. Similar protection for other generators with I_2^2T constants between "30" and "90" is obtained by settings of the time dial. Figure 4 shows the necessary time dial settings for various I_2^2T constants. By

TABLE I
OVERCURRENT UNIT BURDEN AND THERMAL RATING

Phase	Continuous Rating-Amps	One Second Rating-Amps	Watts at 5 Amps	Volt Amps at 5 Amps	Power Factor Angle
1	5	100	5.3	5.3	0°
2	5	100	0.0	.98	90° Lag
3	5	100	4.0	7.25	56° Lag

referring to this figure, the time dial can be set so that the relay protects different generators whose I_2^2T constants range from "30" to "90".

Fig. 6 demonstrates the use of a tap setting lower than the full load current of the machine to accommodate I_2^2T limits of 7 and 10 while still providing wide contact spacing. For this figure a tap setting of 3 is used with a machine full load current of 4.

- * Typical time-current curves of the relay are shown in figure 7. Minimum pickup is approximately 0.6 of the tap value current. See Table I for burdens and thermal ratings.

Trip Circuit

The main contacts will safely close 30 amperes at 250 volts d-c and the seal-in contacts of the indicating contactor switch will safely carry this current long enough to trip a circuit breaker.

The indicating contactor switch has two taps that provide a pickup setting of 0.2 or 2 amperes. To change taps requires connecting the lead located in front of the tap block to the desired setting by means of a screw connection.

Indicating Contactor Switch (ICS)

- 0.2 ampere tap 6.5 ohms d-c resistance
- 2.0 ampere tap 0.15 ohms d-c resistance

SETTING CALCULATIONS

Determine from the machine manufacturer the permissible I_2^2T constant. From figure 4, find the required time dial setting.

Depending upon which curve was used in establishing the time dial setting, determine the tap value.

For I_2^2T producing an intersection on the upper curve, use a tap setting equal to or less than machine

full load. For example, a conventionally cooled turbine generator may have a limit of $I_2^2T = 30$. Where I_2 is negative sequence current expressed in terms of per unit stator current at rated KVA and T is in seconds. This produces an intersection on the upper curve of figure 4 showing a time dial setting of 4. If the machine full load current (based upon the cooling conditions at which I_2^2T is stated) is 4.4 amperes, use a tap setting of 4.2 amperes.

For I_2^2T producing an intersection on the lower curve, use a tap setting equal to or lower than $\frac{3}{4}$ of machine full load current. For example, an inner-cooled turbine generator may have a limit of $I_2^2T = 10$. This produces an intersection on the lower curve of figure 4, showing a time dial setting of 2.5. If the machine full load current (based upon the cooling conditions at which I_2^2T is stated) is 4 amperes, use a tap setting of 3 amperes.

This approach gives a conservative, protective characteristic.

SETTING THE RELAY

Overcurrent Unit

Insert the tap screw in the appropriate tap determined under "Setting Calculations".

Adjust the time dial setting to the value determined under "Setting Calculations".

Indicating Contactor Switch (ICS)

Select the 0.2 or the 2.0 ampere tap setting depending upon the type of device being operated by the relay. This selection is made by connecting the lead located in front of the tap block to the desired tap.

INSTALLATION

The relays should be mounted on switchboard panels or their equivalent in a location free from dirt,

TYPE COQ RELAY

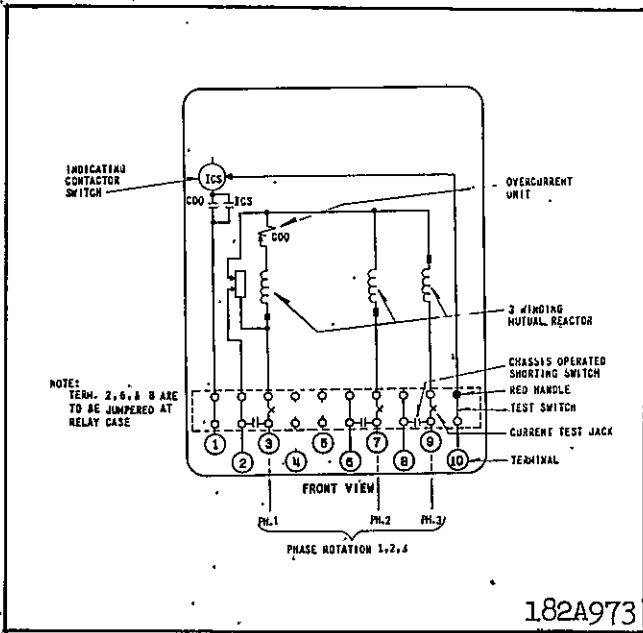

Fig. 2. Internal Schematic of the Type COQ Relay in the FT21 Case - Neutral Formed in Relay.

moisture, excessive vibration, and heat. Mount the relay vertically by means of the four mounting holes on the flange for semi-flush mounting or by means of the rear mounting stud or studs for projection mounting. Either a mounting stud or the mounting screws may be utilized for grounding the relay. The electrical connections may be made directly to the terminals by means of screws for steel panel mounting or to the terminal studs furnished with the relay for thick panel mounting. The terminal studs may be easily removed or inserted by locking two nuts on the stud and then turning the proper nut with a wrench.

For detailed FT case information refer to I.L. 41-076.

ADJUSTMENTS AND MAINTENANCE

The proper adjustments to insure correct operation of this relay have been made at the factory and should not require readjustment after receipt by the customer. If the adjustments have been changed or the relay taken apart for repairs, the instructions below should be followed.

Acceptance Tests

The following tests are recommended when the relay is received from the factory. If the relay does not perform as specified below, the relay either is not calibrated or it contains a defect.

Apply approximately 5 amperes, 3 phase positive sequences current on 3 amp tap and see that relay does not operate.

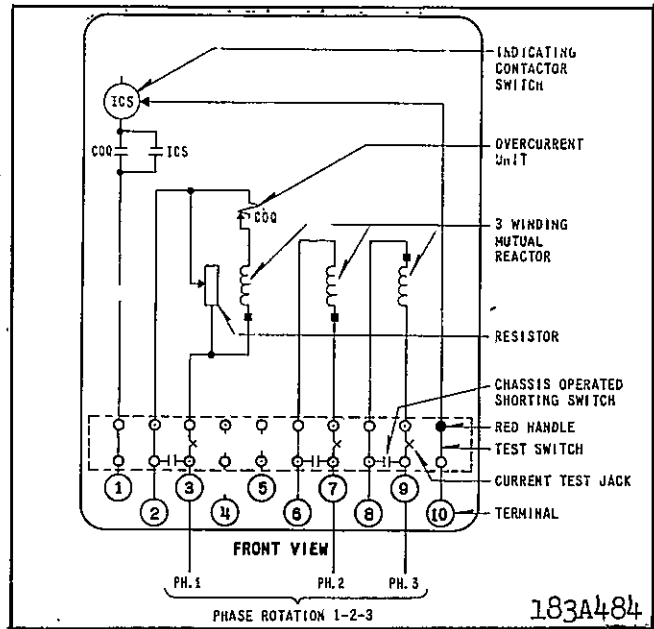

Fig. 3. Internal Schematic of the Type COQ Relay in the FT21 Case - For Forming Neutral External to Relay.

Set relay at #11 time dial and jumper terminals 2, 6 and 8. Set tap 3 and apply 26.0 amperes across terminals 3 to 7. (See figure 10.)

Time of operation with relay in the case should be 3.2 seconds \pm 8%.

Repeat test with relay on 5.0 tap and 43.3 amperes across terminals 7 and 9. Time of operation should be 3.2 seconds \pm 8%.

Routine Maintenance

All the relays should be inspected periodically and the time of operation should be checked at such time intervals as may be dictated by experience to be suitable to the particular application. Phantom loads should not be used in testing induction-type relays because of the resulting distorted current wave form which produces an error in timing.

All contacts should be cleaned periodically. A contact burnisher S#182A836H01 is recommended for this purpose. The use of abrasive material for cleaning contacts is not recommended, because of the danger of embedding small particles in the face of the soft silver and thus impairing the contact.

Overcurrent Unit

Apply a single phase current of 8.66 times tap value (5 per unit negative sequence current) and check that time of operation is in accordance with figure 7.

Indicating Contactor Switch (ICS)

Close the main relay contacts and pass sufficient d-c current through the trip circuit to close the contacts of the ICS. This value of current should not be greater than the particular ICS tap setting being used. The indicator target should drop freely.

Calibration

If the factory calibration has been disturbed, the following procedure should be followed to calibrate the relay.

Filter

To adjust the filter resistor tap for no response to positive-sequence current, remove relay from case and proceed as follows:

- a. Jumper switch jaws 2 and 6.
- b. Remove overcurrent unit, tap screw
- c. Pass 10 amperes into switch jaw 3 and out switch jaw 7.
- d. With a 0-15 volt, Rectox type voltmeter, measure and record voltage between switch jaw 3 and the tap plate.
- e. Now measure the voltage across the resistor. Adjust top filter resistor position until this voltage is 1.73 times the reading from (d) above. (For relays wired per figure 2 connect the voltmeter to switch jaw 3 and to the top filter resistor screw connection (see figure 1). (For relays wired per figure 3 connect voltmeter across switch jaws 2 and 3.)

To eliminate zero sequence response (relays wired per figure 2 only), remove tap screw, and connect per figure 10: Apply $I_x = 5$ amperes; $I_y = 10$ amperes. Measure voltage from terminal 3 to top filter resistor screw connection (see figure 1). Adjust the neutral filter resistor tap until measured voltage is zero.

Overcurrent Unit

Turn time dial until stationary contact is deflected against the backstop. Adjust, if necessary, so that "0" mark on time dial coincides with index. Then, with time dial at "0" wind up spring until about $5\frac{1}{2}$ convolutions show. From this preliminary setting, and using 3 tap and time dial setting of "11", adjust the permanent magnet until the relay operates in 8.2 seconds with 15.6 amperes single phase or 3 per unit between terminals 3 and 7 per Fig. 10. This adjustment is made by means of the damping magnet screw.

Next adjust the spring tension until the relay will close contacts in 90 seconds with 5.2 amperes single phase (tap value or one per unit negative sequence current) applied between terminals 3 and 7. This adjustment is made by means of the spiral spring adjuster. All spring convolutions must be free.

RENEWAL PARTS

Repair work can be done most satisfactorily at the factory. However, interchangeable parts can be furnished to the customers who are equipped for doing repair work. When ordering parts, always give the complete nameplate data.

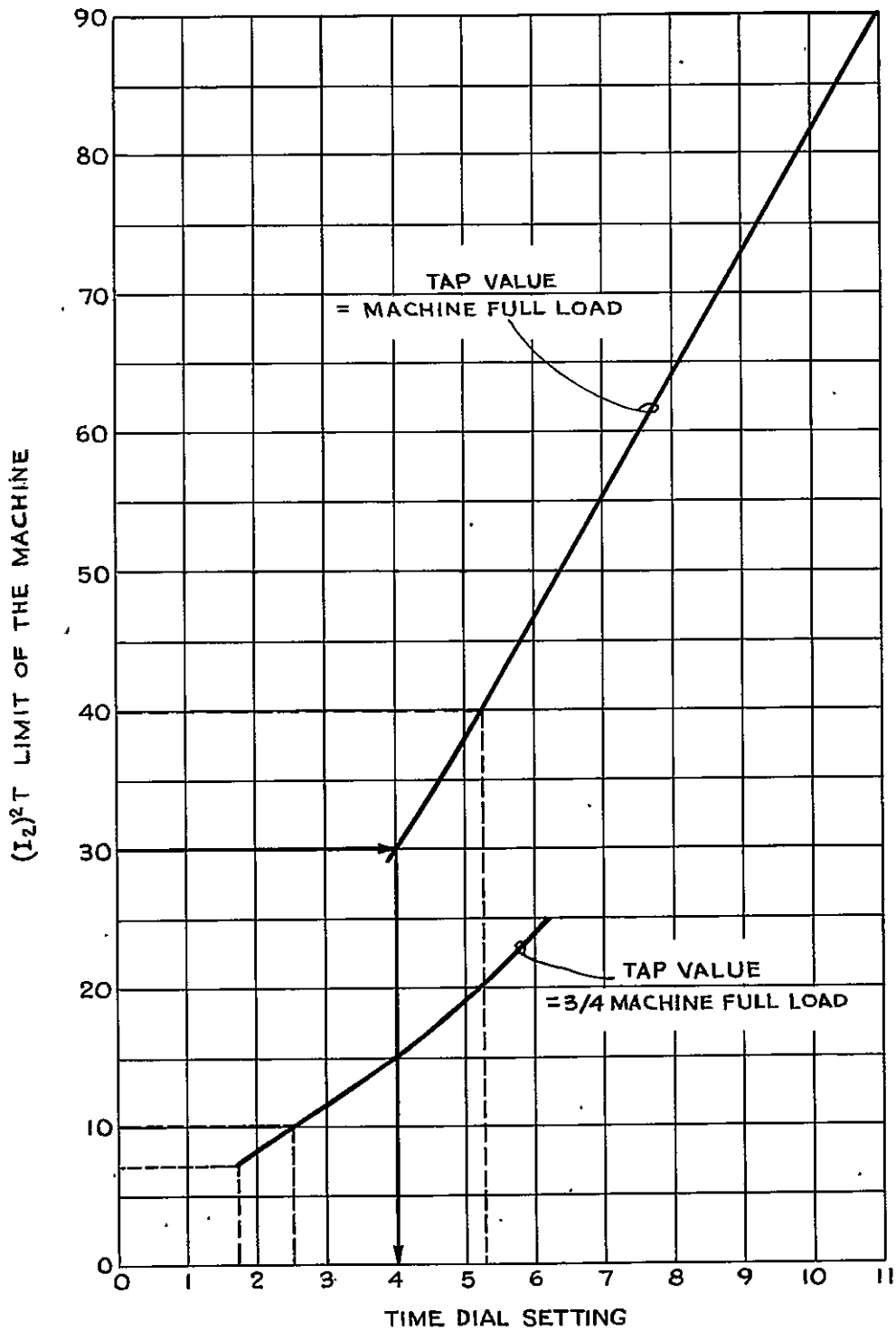

27-D-5609

Fig. 4. Required COQ Time Dial Setting Versus Generator Constant.

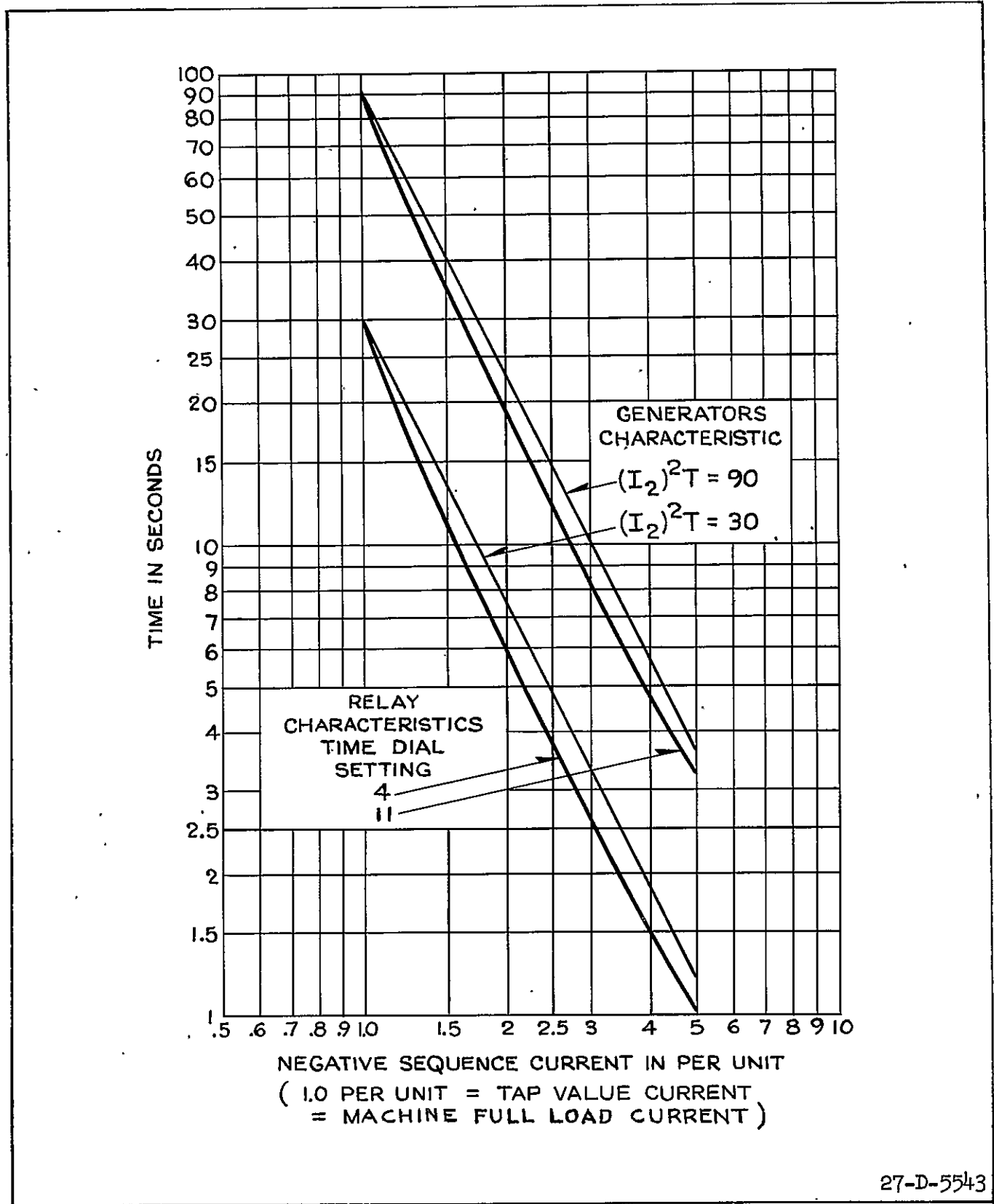

27-D-5543

Fig. 5. Comparison of Relay and Generator Characteristics - Time Versus Negative-Sequence Current, For an $I_2^2 T$ Factor From 30 to 90.

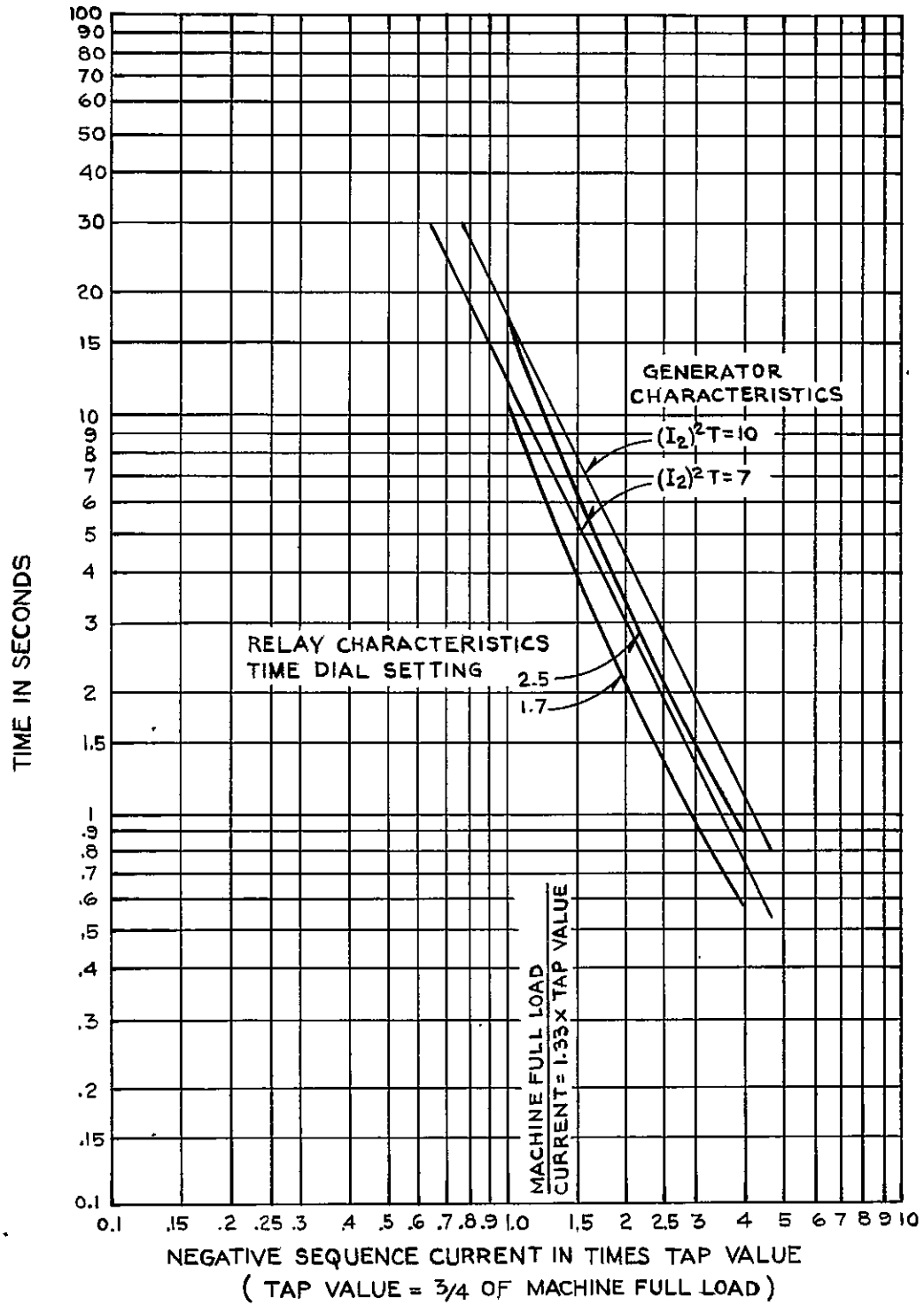

670B901

Fig. 6. Comparison of Relay & Generator Characteristics - Time Versus Negative Sequence Current, For an $\frac{I_2^2 T}{2}$ Factor From 7 to 10.

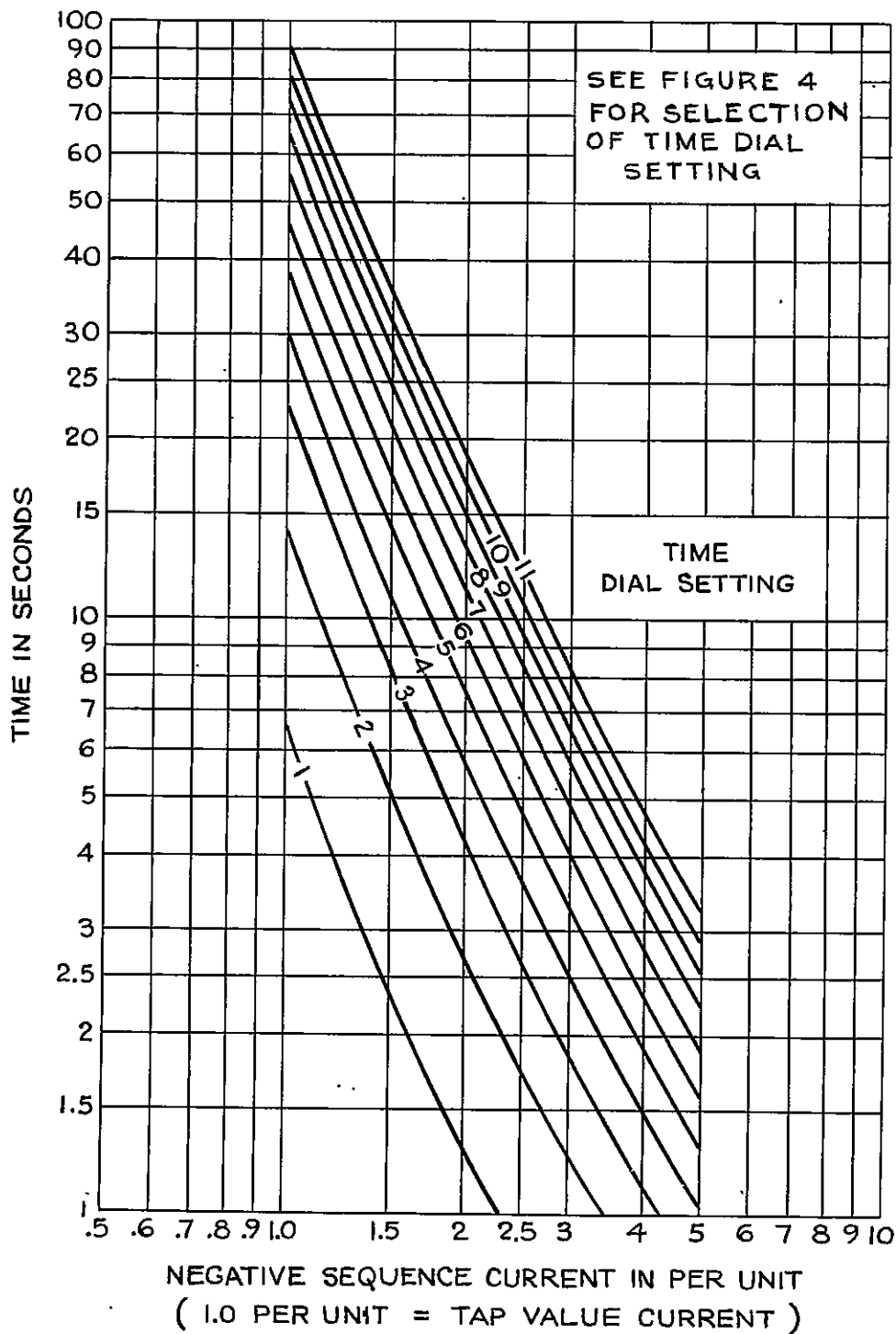

27-D-5544

Fig. 7. Relay Time-Current Curve.

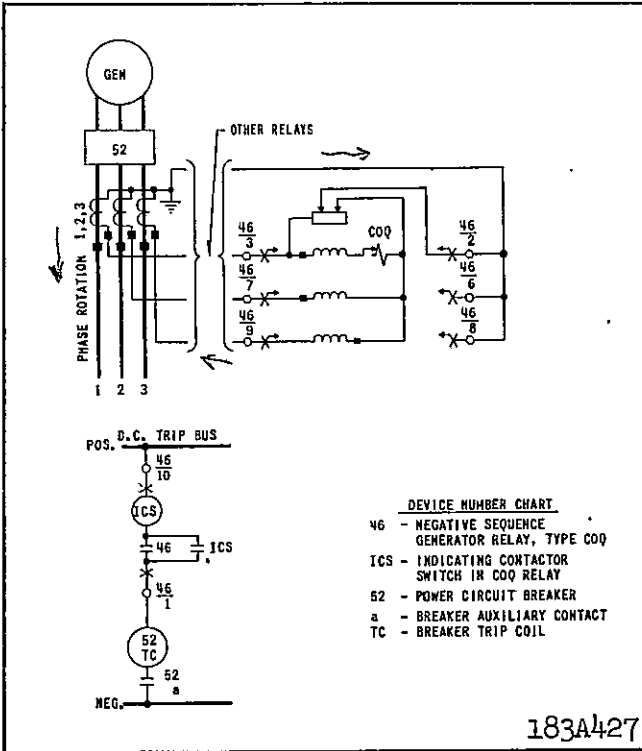
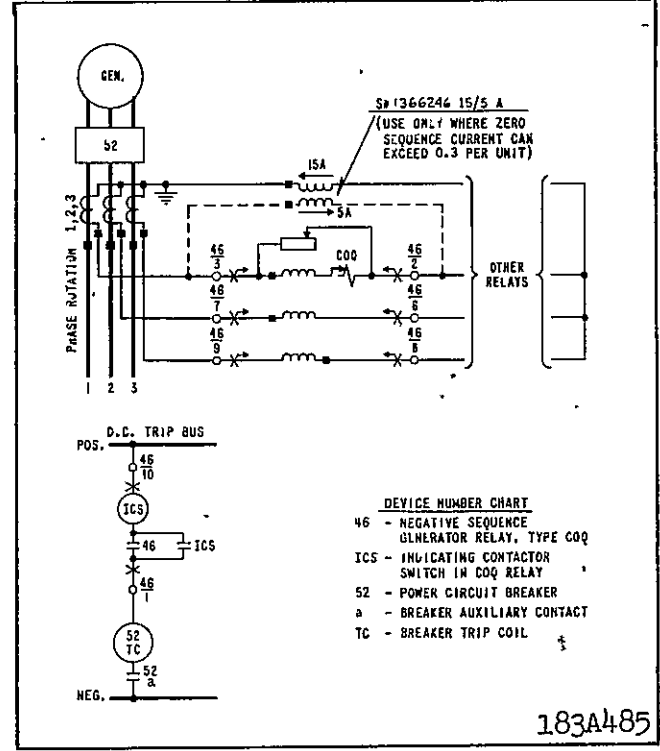

Fig. 8. External Schematic of the COQ Relay - Neutral Formed Within Relay.



*** Fig. 9. External Schematic of the COQ Relay - Neutral Formed Externally.**

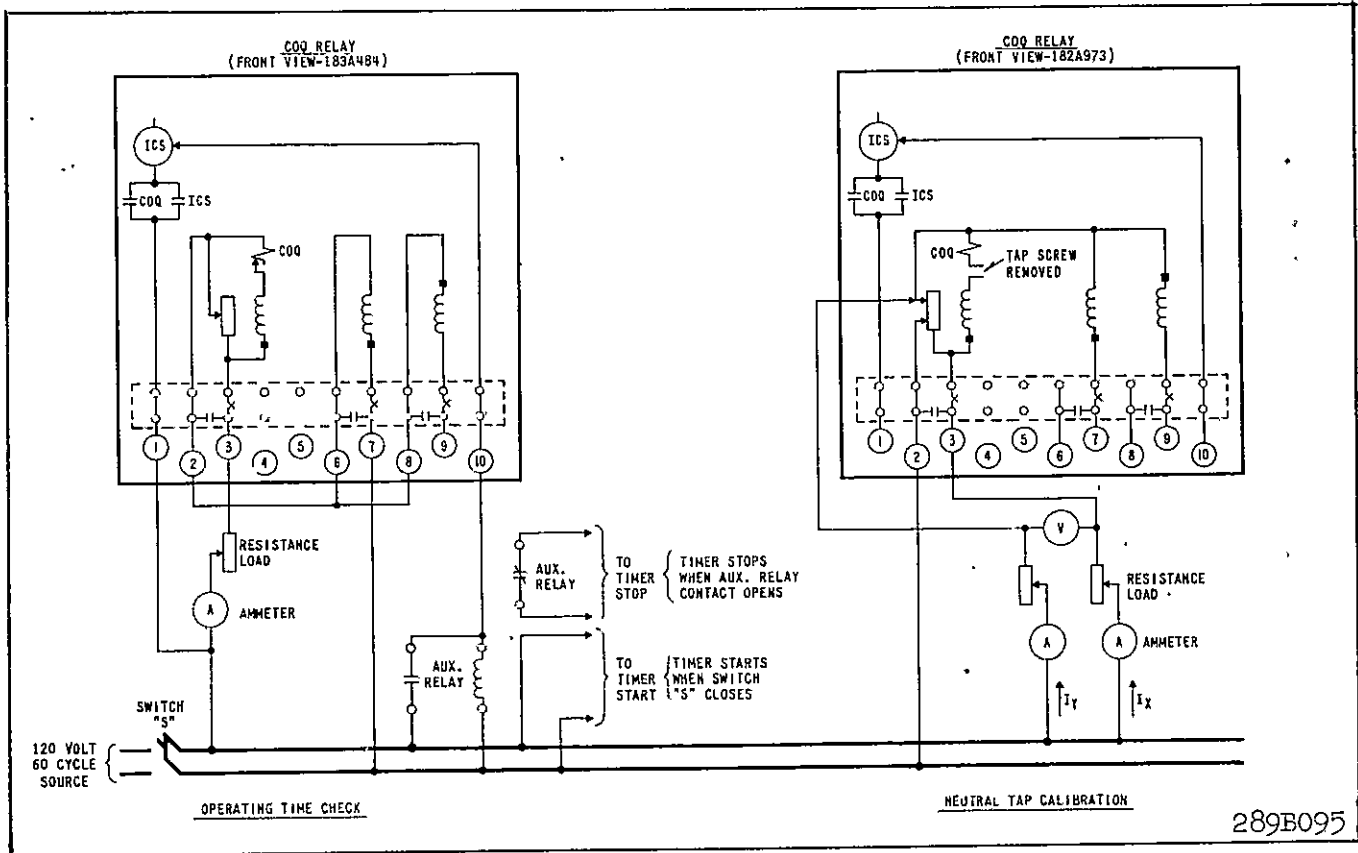

Fig 10. Diagram of Test Connections for COQ Relay.

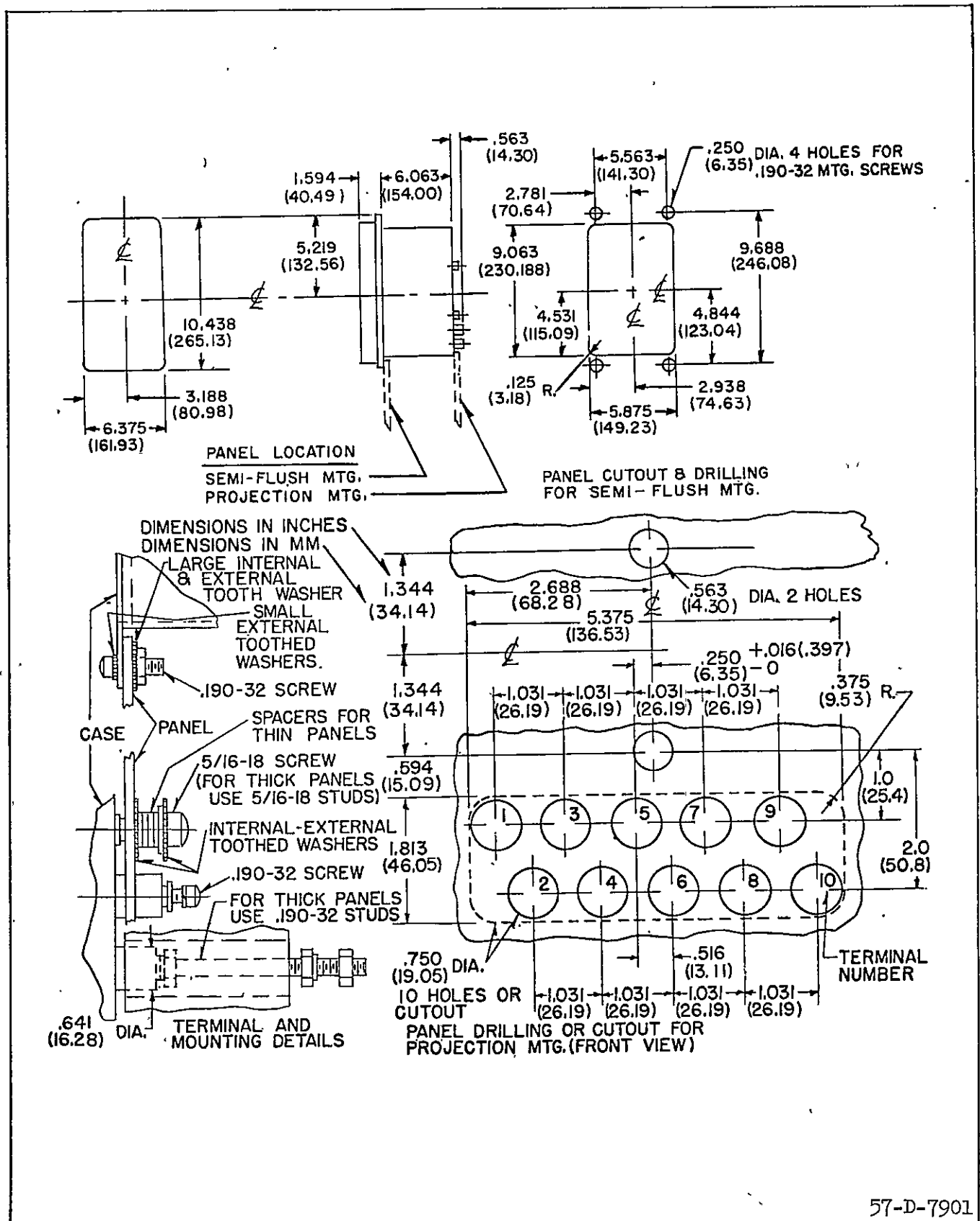
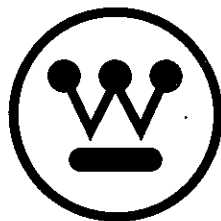

Fig. 11. Outline and Drilling Plan for the COQ Relay in the FT21 Case.



WESTINGHOUSE ELECTRIC CORPORATION
RELAY-INSTRUMENT DIVISION

NEWARK, N. J.

Printed in U.S.A.