

METAL-CLAD SWITCHGEAR

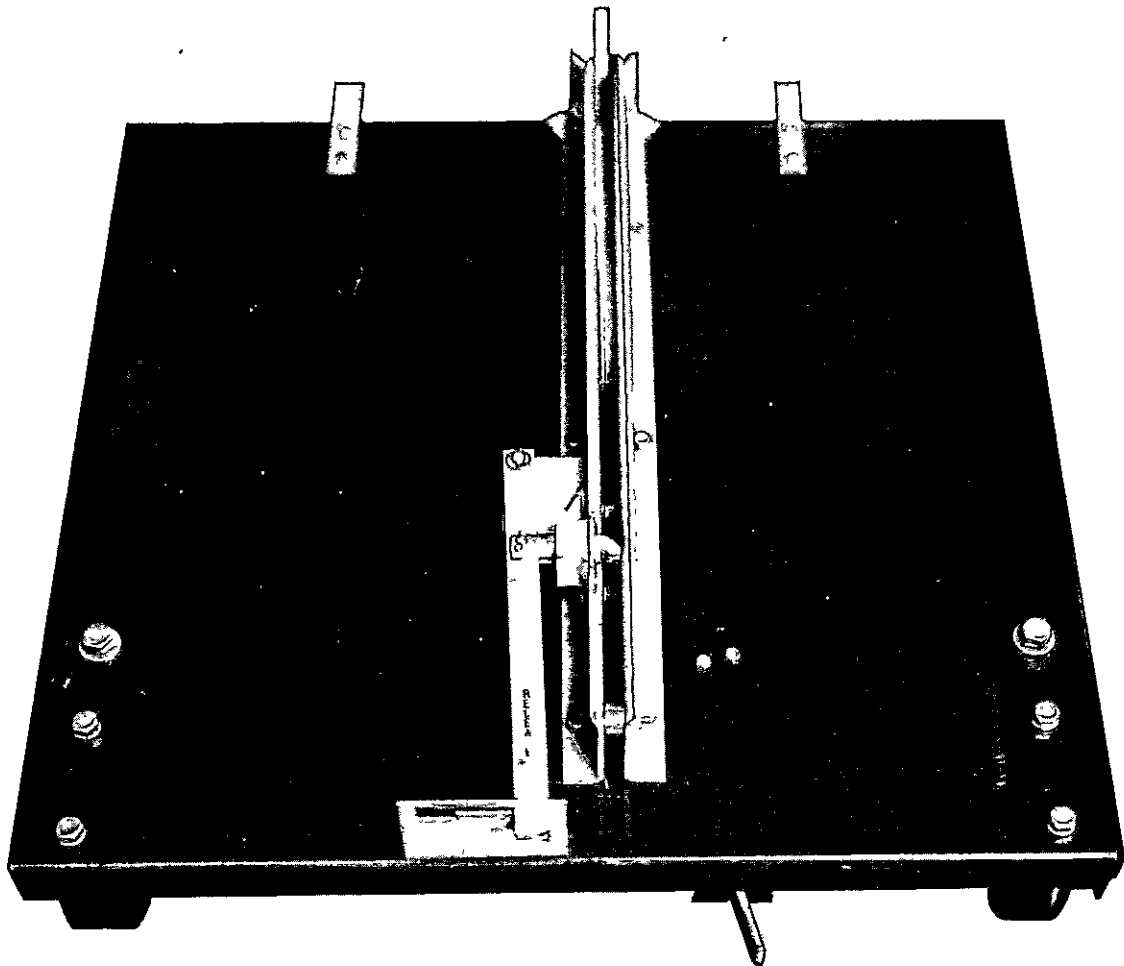

INSTRUCTIONS

BREAKER TRANSFER DOLLY
FOR USE WITH
OUTDOOR TYPE 15HV METAL-CLAD SWITCHGEAR



I-T-E CIRCUIT BREAKER COMPANY • PHILADELPHIA 30, PENNSYLVANIA



INSTRUCTIONS FOR OPERATING DOLLY FURNISHED WITH OUTDOOR TYPE 15HV METAL-CLAD SWITCHGEAR

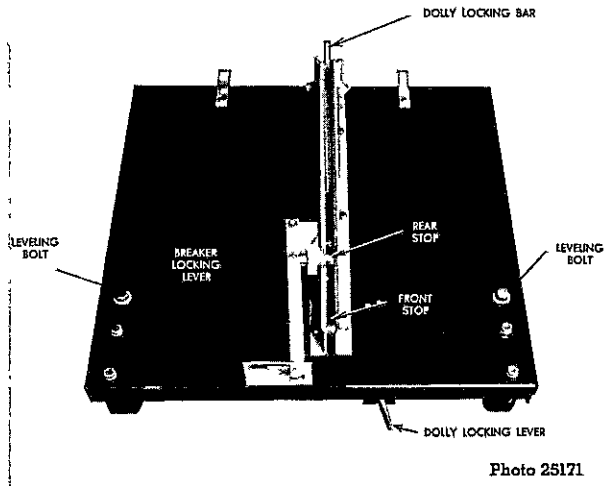

Photo 25171

Fig. 1. A dolly like the one shown is furnished with each outdoor type 15HV metal-clad switchgear installation; to facilitate circuit breaker removal and insertion, since the circuit breaker compartment floor is raised from the ground.



Photo 25170

Fig. 2. The dolly is maneuvered into position by means of a fifth wheel device, as shown. The circuit breaker compartment door must be fully open. To insure proper vertical alignment of the dolly with the gear, raise or lower dolly as required, by means of leveling bolts (See Fig. 1)

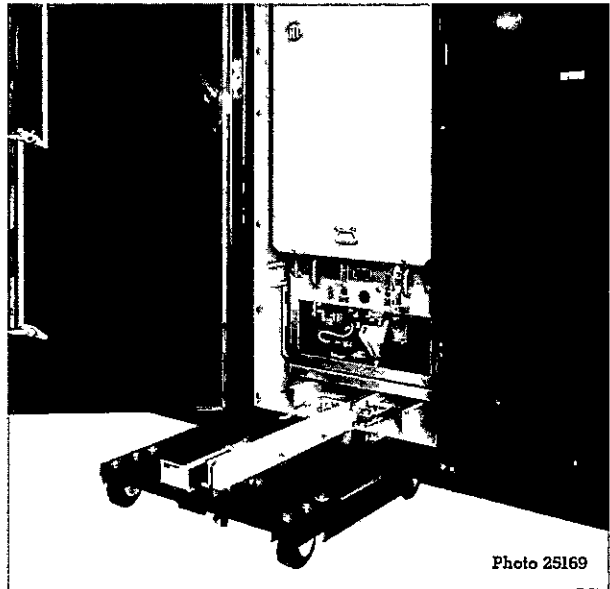

Photo 25169

Fig. 3. After the dolly is aligned vertically and horizontally, it is pushed against the gear. Before attempting to move breaker out, make sure that the dolly locking bar is engaged, and pull dolly locking bar upwards, if necessary. Move breaker locking bar to the right.

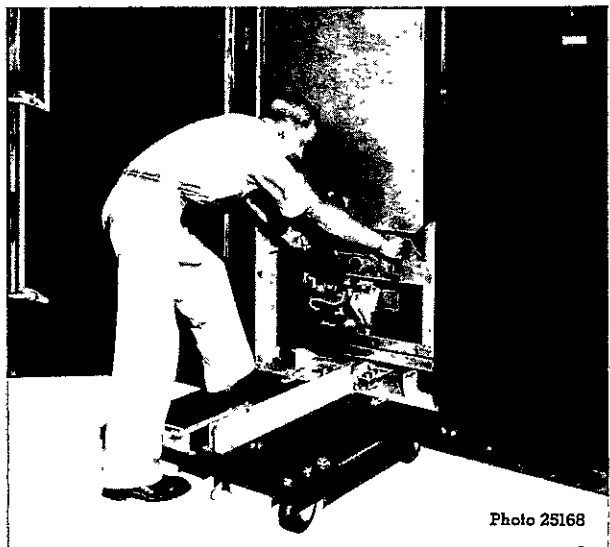

Photo 25168

Fig. 4. To remove the circuit breaker, it must be first racked out into the test position, and unlocked. (See Instruction Bulletin on breaker). Then the breaker is pulled out as shown.

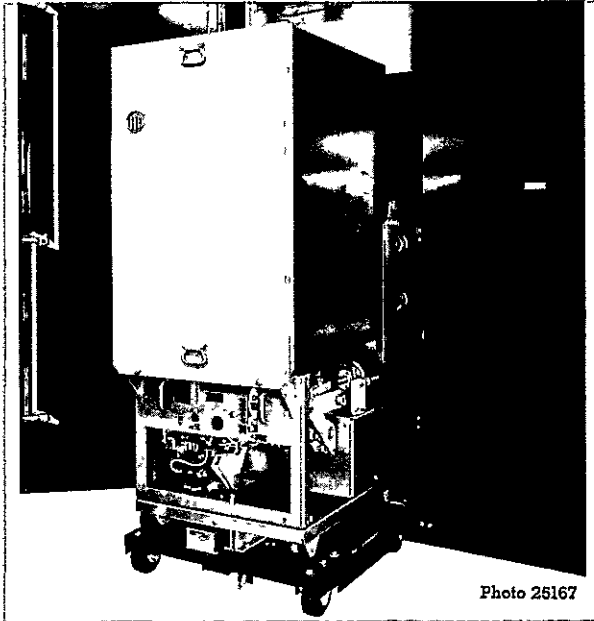

Photo 25167

Fig. 5. The breaker is moved out until the guide bar on its bottom touches the front stop on the dolly. Before moving dolly make sure that breaker locking lever is in extreme right position.

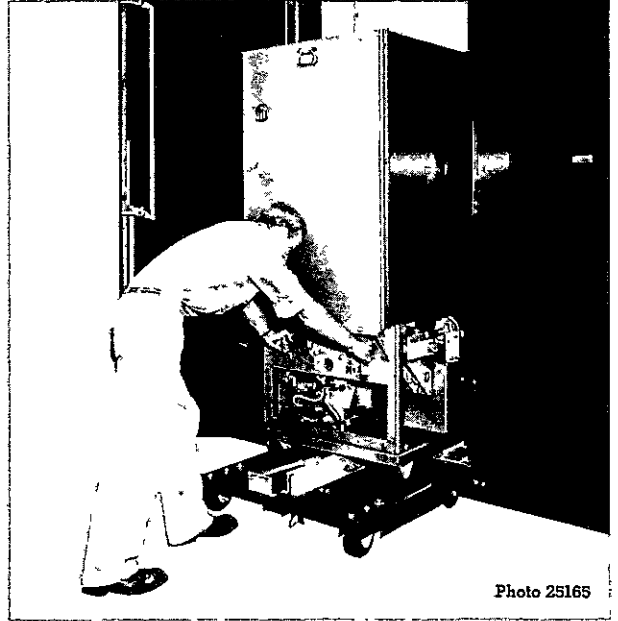

Photo 25165

Fig. 7. To insert circuit breaker, move dolly against gear as described under Figs. 2 and 3. Then move breaker locking bar to the left and push breaker in as shown above.

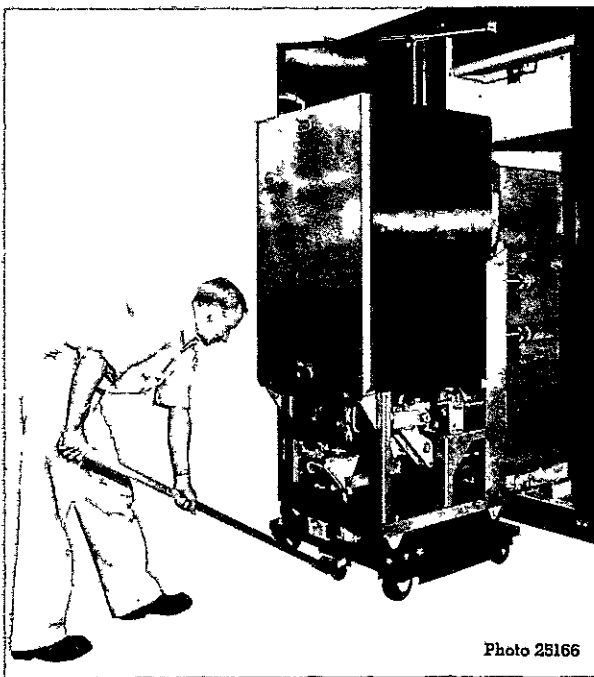

Photo 25166

Fig. 6. To move dolly apply fifth wheel device as shown, push dolly locking lever down as shown in Fig. 8, and pull fifth wheel device.

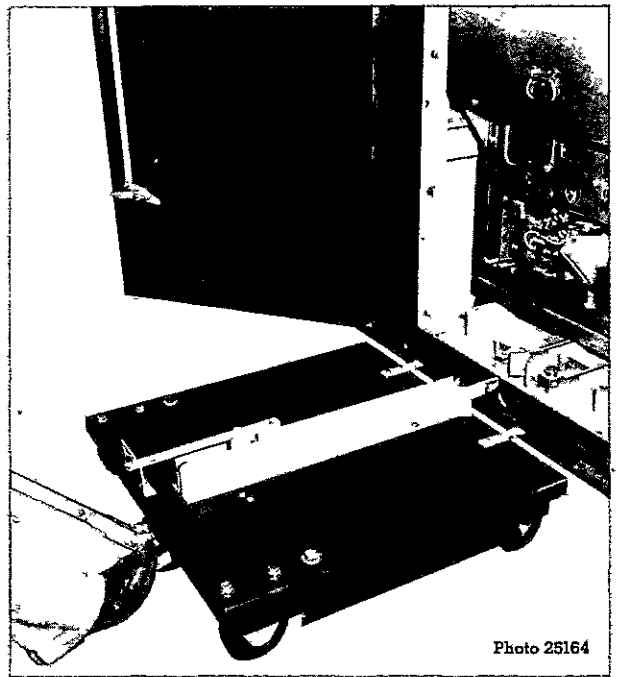

Photo 25164

Fig. 8. To remove dolly, apply fifth wheel device, push dolly locking lever down with foot as shown and pull on fifth wheel device.

Consult Our Sales Offices

The I-T-E Circuit Breaker Company is represented in all principal cities of the United States and Canada. These representatives are experienced and are competent to make correct applications, as well as give complete information and prices. We suggest you consult the representative nearest you.

District and Sales Representatives Offices

- ATLANTA, GA.**
I-T-E Circuit Breaker Company,
403 W. Ponce de Leon Ave., Room 108,
Decatur, Ga.
- BALTIMORE, MD.**
I-T-E Circuit Breaker Company,
2321 Maryland Avenue,
Baltimore 18, Md.
- BATON ROUGE, LA.**
Gregory-Salisbury & Company, Inc.,
4445 Sweetbriar Street,
Baton Rouge, La.
- BIRMINGHAM, ALABAMA**
Jos. W. Eshelman & Co., Inc.,
1812 28th Ave., South, Homewood,
P. O. Drawer 5768,
Birmingham 9, Ala.
- BOSTON, MASS.**
I-T-E Circuit Breaker Company
31 St. James Ave.,
Boston 18, Mass.
- BUFFALO, N. Y.**
I-T-E Circuit Breaker Company,
Rm. 1728, Rand Bldg.,
Buffalo 3, N. Y.
- BUTTE, MONT.**
R. E. McDonough Company,
829 Maryland Ave., P. O. Box 278,
Butte, Mont.
- CHARLESTON, W. VA**
W. J. Hess & Son,
3145 Washington St., West,
P. O. Box 10066,
Charleston 2, W. Va.
- CHARLOTTE, N. C.**
E. H. Gilliam Company,
108 N. Caldwell Street,
P. O. Box 4035, Charlotte 4, N. C.
- CHICAGO, ILL.**
I-T-E Circuit Breaker Company,
Bankers Bldg., Rm. 2900,
105 W. Adams St., Chicago 3, Ill.
Hooper-Green Company,
7716 West North Ave.,
Chicago 5, Ill.
- CINCINNATI, OHIO**
I-T-E Circuit Breaker Company,
6953 Thorndike Rd.,
Cincinnati 27 (Mariemont), Ohio
- CLEVELAND, OHIO**
I-T-E Circuit Breaker Company,
831 Hanna Bldg., 14th St. & Euclid Ave.,
Cleveland 16, Ohio
- DALLAS, TEXAS**
Butler & Land,
5538 Dyer St.,
Dallas 6, Tex.
First class mail & air mail—P. O. 8085
- DENVER, COLO.**
I-T-E Circuit Breaker Company,
Denham Bldg., Rm. 620,
635-18th St.,
Denver 2, Colo.
- DETROIT, MICH.**
I-T-E Circuit Breaker Company,
Guardian Bldg., Rm. 1512,
500 Griswold St.,
Detroit 26, Mich.
- EL PASO, TEXAS**
Electrical & Mechanical Supply Co., Inc.
P. O. Box 137,
2000 Texas Street,
El Paso, Texas
- HOUSTON, TEXAS**
I-T-E Circuit Breaker Company,
P. O. Box 6466 (Mail),
2032 Dunlavy St.,
Houston 6, Texas
- INDIANAPOLIS, IND.**
Geo. A. Wright,
609 Roosevelt Bldg.,
Indianapolis 4, Ind.
Hooper-Green Company,
8216 Carrollton Ave.,
Indianapolis 20, Ind.
- JACKSON, MISS.**
Gregory-Salisbury & Company, Inc.,
429 South West St.,
P.O. Box 1085,
Jackson 5, Mississippi
- JACKSONVILLE, FLORIDA**
Robert P. Smith & Company,
P. O. Box 5085, Jacksonville 7, (Mail),
2031 Hendricks Ave.,
Jacksonville 7, Florida
- KANSAS CITY, MO.**
J. E. Murray & Company,
1435 Clay St.,
Kansas City 16, Mo.
- LITTLE ROCK, ARKANSAS**
Gregory-Salisbury & Company, Inc.,
P. O. Box 2698 (Mail),
Little Rock, Ark.,
400 Schall St., Rm. 114,
Little Rock, Ark.
(Express and heavy shipments)
- LOS ANGELES, CALIF.**
I-T-E Circuit Breaker Company,
130 S. Atlantic Blvd.,
Los Angeles 22, Calif.
- MIAMI, FLA.**
Lee-Smith Company,
919 Langford Building,
Miami 32, Fla.
- MINNEAPOLIS, MINN.**
I-T-E Circuit Breaker Company,
711 Plymouth Bldg.,
Hennepin and Sixth St.,
Minneapolis 2, Minn.
- NEW ORLEANS, LA.**
Gregory-Salisbury & Company, Inc.,
820 Julia St.,
New Orleans 12, La.
- NEW YORK, N. Y.**
I-T-E Circuit Breaker Company,
233 Broadway,
New York 7, N. Y.
- OMAHA, NEB.**
Conrad R. Bangh,
WOW Bldg., Rm. 524,
14th and Farnam St.,
Omaha 2, Neb.
- PHILADELPHIA, PA.**
I-T-E Circuit Breaker Company,
101 N. 33rd St., Suite 201,
Philadelphia 4, Pa.
- PITTSBURGH, PA.**
I-T-E Circuit Breaker Company,
210 Grant Street,
Pittsburgh 19, Pa.
Donald J. Baker,
300 Mt. Lebanon Blvd., Suite 304,
Pittsburgh 34, Pa.
- PORTLAND, ORE.**
Garland Affolter Eng'g Corp.,
1233 N. W. 12th Avenue,
Portland 9, Ore.
- ST. LOUIS, MO.**
I-T-E Circuit Breaker Company
7 N. Brentwood Blvd.,
Clayton, St. Louis 8, Mo.
- SALT LAKE CITY, UTAH**
Riter Engineering Company,
Kearns Bldg., Room 422,
136 S. Main Street,
Salt Lake City 1, Utah
- SAN FRANCISCO, CALIF.**
I-T-E Circuit Breaker Company,
320 Fourth Street,
San Francisco 7, Calif.
- SEATTLE, WASH.**
Garland Affolter Eng'g Corp.,
2603 Western Ave.,
Seattle 1, Wash.
- SHREVEPORT, LA.**
Butler & Land,
3758 Eileen Ave.,
P. O. Box 3584 (Mail)
Shreveport, La.
- SYRACUSE, N. Y.**
I-T-E Circuit Breaker Company,
Rm. 207, O'Donnell Bldg.,
321 Erie Blvd., West,
Syracuse 2, N. Y.
- TAMPA, FLA.**
Robert P. Smith & Company,
4102 Tyson Avenue,
P. O. Box 13103 (Mail),
Tampa 11, Fla.
- TUCSON, ARIZ.**
Central Station Equipment Company,
2323 Aviation Highway,
Tucson, Arizona
- WASHINGTON, D. C.**
I-T-E Circuit Breaker Company,
1012 14th St., N. W.,
Washington 5, D. C.
- WILKES-BARRE, PA.**
I-T-E Circuit Breaker Company,
Miners National Bank Bldg., Suite, 626
Market and Franklin Sts.,
Wilkes-Barre, Pa.
- CANADA—FACTORY**
Eastern Power Devices Limited,
29 Wabash Ave.,
Toronto 3, Ont.
- WINNIPEG**
MacKay-Morton Limited,
183 James Ave., East,
Winnipeg, Manitoba
- MONTREAL**
Eastern Power Devices Limited,
Rm. 1021
620 Cathcart St.
Montreal, Quebec
- VANCOUVER**
Eastern Power Devices Limited,
Room 4,
416 West Pender Street,
Vancouver, British Columbia
- REGINA, SASKATCHEWAN**
MacKay-Morton Limited,
(Saskatchewan),
226 Dewdney Ave.,
Regina, Saskatchewan
- EDMONTON, ALBERTA**
MacKay-Morton (Western) Ltd.,
10304-105th Street,
Edmonton, Alberta
- CALGARY, ALBERTA**
MacKay-Morton (Western) Ltd.,
705-11th Ave. West,
Calgary, Alberta
- HALIFAX, N. S.**
Foulis & Bennett Elec. Ltd.,
4 Atlantic Avenue,
Halifax, Nova Scotia
- EXPORT (Except Canada)**
Philips Export Company,
100 E. 42nd St.,
New York 17, N. Y.

General Offices and Factory:

PHILADELPHIA

19th and Hamilton Streets, Phila. 30, Pa.

LOCUST 7-1420